

STRATA KITCHENS

TOOLS NEEDED/

POWER DRILL

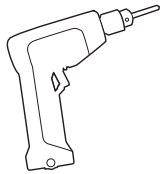

3MM DRILL BIT

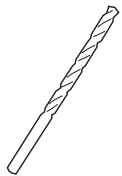

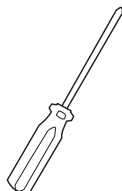

PHILLIPS HEAD SCREW DRIVER



THIS PACK INCLUDES/

FRIDGE CABINET TYPE/

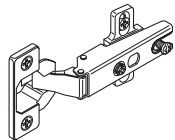
	900MM FRIDGE CABINET		
 50MM CABINET FIX SCREW 28MM HEAD HOLE SCREW 60MM HEAD HOLE SCREW (USED IN THE INSTALLATION)	16 08 04		
 WHITE COVER CAP (USED IN THE INSTALLATION)	12		
 DOWEL PIECES	04		
 110° HINGE & PLATE	02		
DOOR BUFFER	02		
GAS STAY	01		
# x 280MM BOTTOM	01		
# x 280MM TOP	01		
# x 500MM BACK	01		
# x 500MM SIDE	02		

FRIDGE CABINET/ INSTRUCTIONS

HOW TO ASSEMBLE/ STEPS 01-04 OF 04

STEP ONE/01

Place side panel on a flat surface with the edge strip facing the front. Join the back, bottom and top panels with location timber dowels and screw fix through the corresponding holes with the 50mm screws.

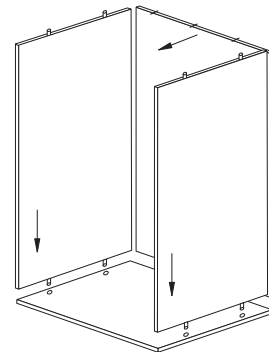

STEP TWO/02

Place the other side panel on top of the secured cupboard using location dowels and fix screw through the corresponding holes with 50mm screws.

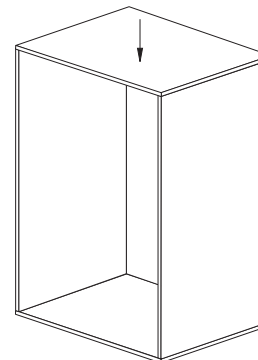

STEP THREE/03A

Mounting of the gas stay to the inside of the cabinet: Mount the bottom grey bracket to the inside side panel of the fridge box at the dimensions noted in the diagram.

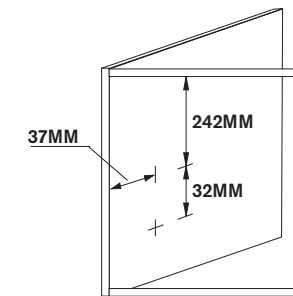

STEP THREE/03B

Mounting of the gas stay to the inside of the door: Mark out and drill pilot holes on the back of the door (see diagram). Fit hinges to door and mount to cabinet (see following page). Then fix the top bracket of the gas stay to the door with 15mm screws.

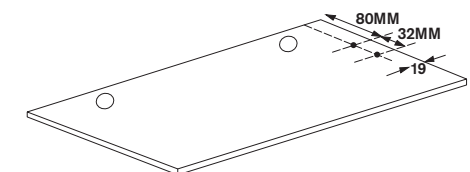

STEP FOUR/04

For installation of this cabinet, refer to the Strata Kitchens Installation Guide, available online at www.stratakitchens.com.au

STRATA KITCHENS

HOW TO MOUNT DOORS/ STEPS 01-06 OF 06

STRATAKITCHENS.COM.AU/
INSTRUCTIONS

STEP ONE/01

Lay the door onto a solid protected surface, with the routed hinge holes facing upwards.

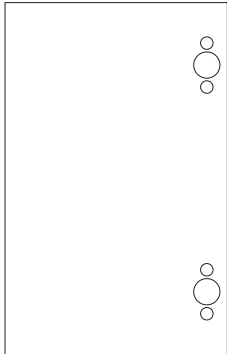

STEP TWO/02

Insert the hinges into the routed holes on the back of the door and fix in place by tightening the hinge screws located either side of the hinge cup. Repeat this step for other doors and hinges, as required.

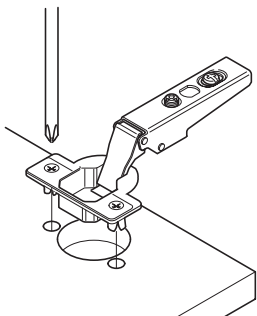

STEP THREE/03

Attach the hinge mounting plate to the inside of the cupboard panel, ensuring that the mounting plate aligns with the hinge placement on the door.

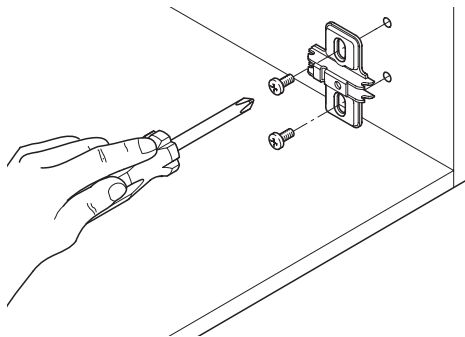

STEP FOUR/04

Attach the door to the mounting plate by pressing the hinge arm onto the mounting plate and ensure that the arm clicks into place.

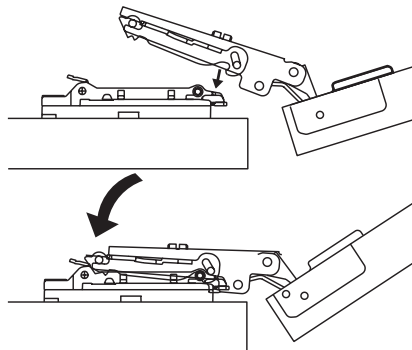

STEP FIVE/05

Adjust doors via the hinge arm and plate to obtain correct gaps.

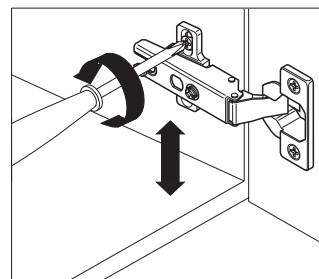
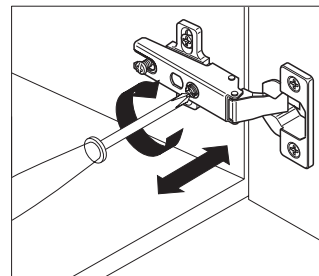
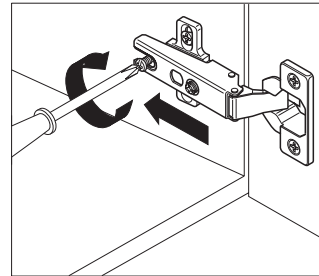

STEP SIX/06

Fix the handle/knob to the door at your desired location. Note: Handles are sold separately.