

STRATA KITCHENS

TOOLS NEEDED/

POWER DRILL

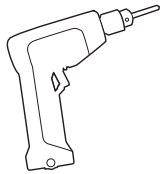

3MM DRILL BIT

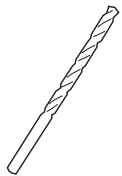



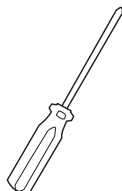



PHILLIPS HEAD SCREW DRIVER

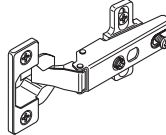

THIS PACK INCLUDES/

RANGEHOOD CABINET TYPE/

	150MM WALL CABINET		
 50MM CABINET FIX SCREW 28MM HEAD HOLE SCREW 60MM HEAD HOLE SCREW (USED IN THE INSTALLATION)	12	04	04
 WHITE COVER CAP (USED IN THE INSTALLATION)	08		
 ADJUSTABLE SHELF SUPPORT	04		
 DOWEL PIECES	04		
 110° HINGE & PLATE	04		
DOOR BUFFER	02		
 # x 265MM SHELF # x 280MM BOTTOM # x 280MM TOP # x 720MM BACK # x 720MM SIDE	01	01	01
	01	01	02

RANGEHOOD CABINET/INSTRUCTIONS

HOW TO ASSEMBLE/ STEPS 01-04 OF 04

STEP ONE/01

Place side panel on a flat surface (adjustable shelf holes facing up) and edge strip facing the front. Join the back, bottom and top panels with location timber dowels and screw fix through the corresponding holes with the 50mm screws.

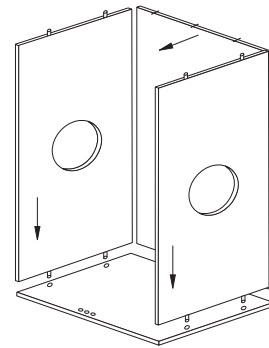

STEP TWO/02

Place the other side panel on top of the secured cupboard using location dowels and fix screw through the corresponding holes with 50mm screws.

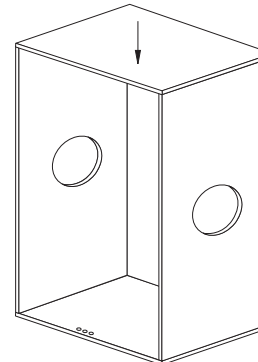

STEP THREE/03

Fit adjustable shelf supports, in the holes on both sides, at your chosen height. Prior to fitting the shelf, you will need to cut out a space for the rangehood flue.

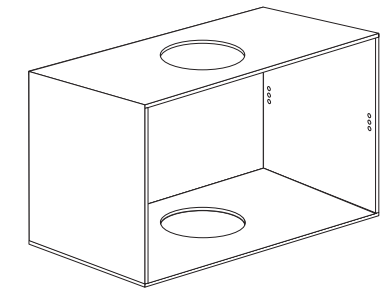

STEP FOUR/04

For installation of this cabinet, refer to the Strata Kitchens Installation Guide, available online at www.stratakitchens.com.au.

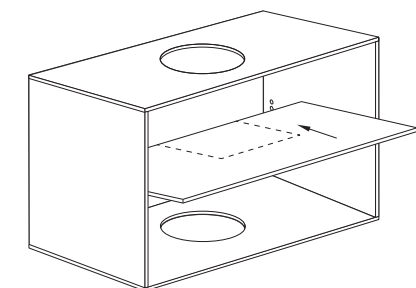

STRATA KITCHENS

HOW TO MOUNT DOORS/ STEPS 01-06 OF 06

STRATAKITCHENS.COM.AU/
INSTRUCTIONS

STEP ONE/01

Lay the door onto a solid protected surface, with the routed hinge holes facing upwards.

Note: Rangehood doors have 4 hinge holes so that they can be used as l/hand or r/hand doors. Use only two hinges per door.

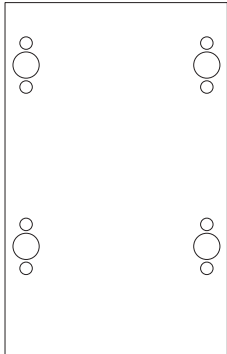

STEP TWO/02

Insert the hinges into the routed holes on the back of the door and fix in place by tightening the hinge screws located either side of the hinge cup. Repeat this step for other doors and hinges, as required.

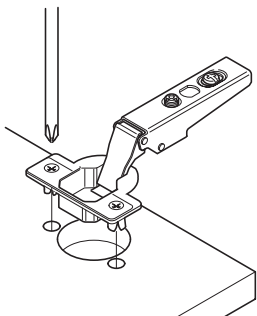

STEP THREE/03

Attach the hinge mounting plate to the inside of the cupboard panel, ensuring that the mounting plate aligns with the hinge placement on the door.

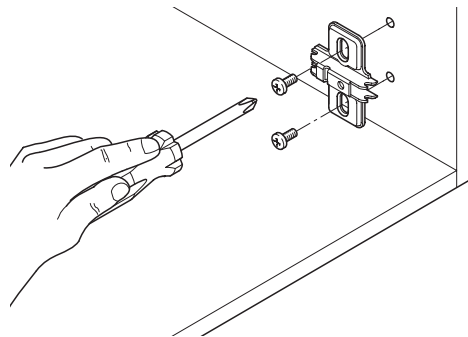

STEP FOUR/04

Attach the door to the mounting plate by pressing the hinge arm onto the mounting plate and ensure that the arm clicks into place.

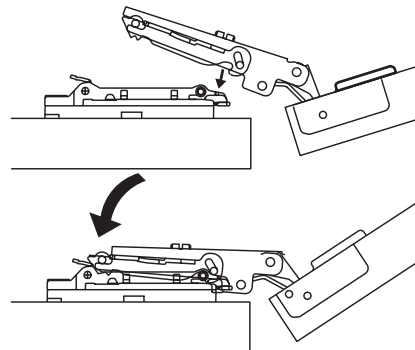

STEP FIVE/05

Adjust doors via the hinge arm and plate to obtain correct gaps.

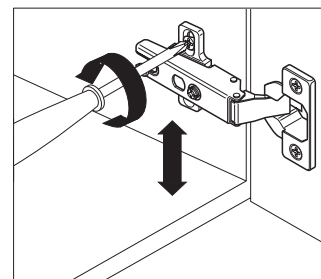
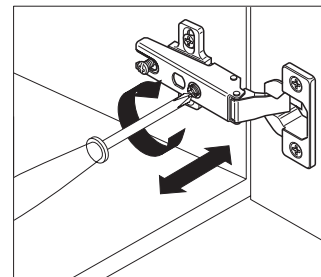
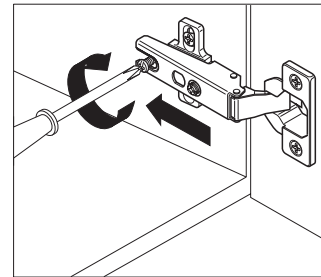

STEP SIX/06

Fix the handle/knob to the door at your desired location. Note: Handles are sold separately.